

**Data sheet | Item number: 832-1206/334-000**

1-conductor male connector; lever; Push-in CAGE CLAMP®; 16 mm<sup>2</sup>; Pin spacing 10.16 mm; 6-pole; 100% protected against mismatching; Strain relief plate; Silver-plated contacts; 16,00 mm<sup>2</sup>; light gray

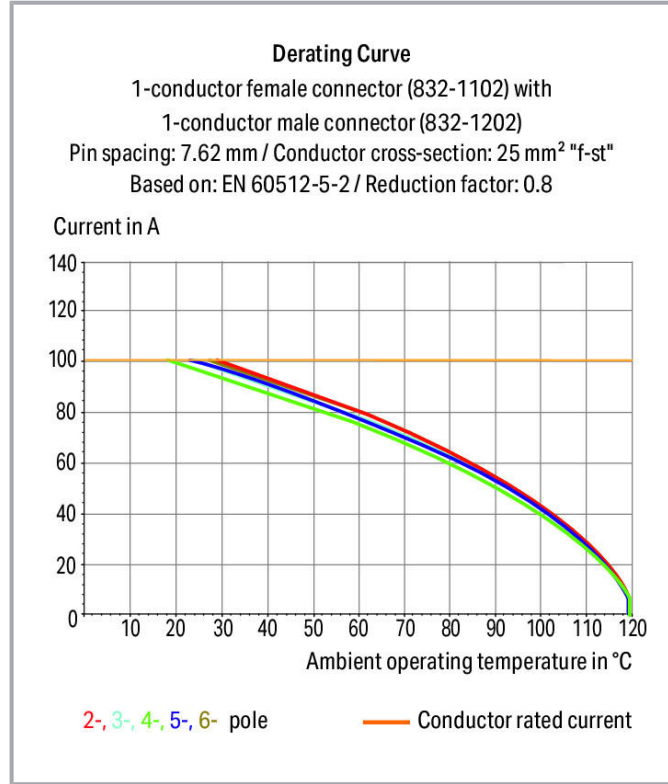

[www.wago.com/832-1206\\_334-000](http://www.wago.com/832-1206_334-000)

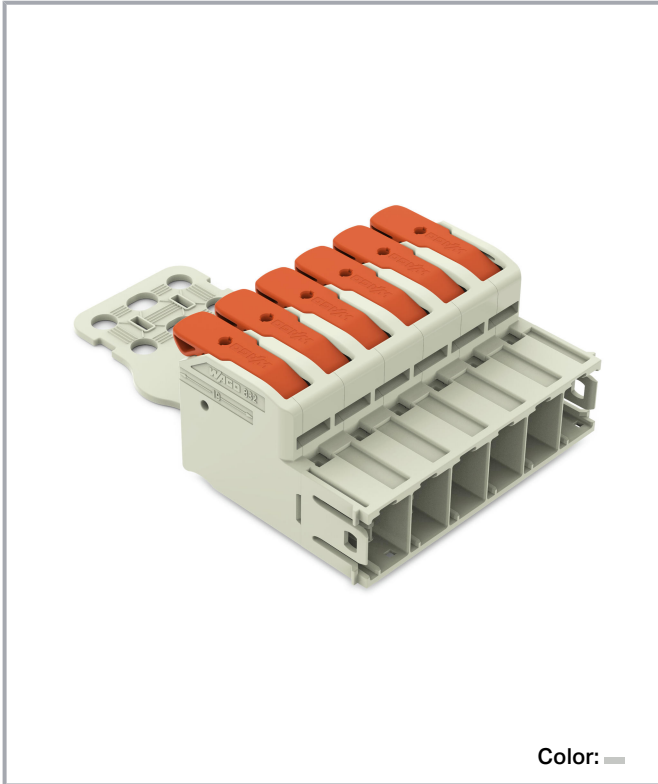

Subject to changes. Please also observe the further product documentation!

WAGO Corporation  
Germantown, WI 53022  
Phone: 1-800-DIN-RAIL (346-7245) | Fax: (262) 255-6222  
Email: [info.us@wago.com](mailto:info.us@wago.com) | Web: [www.wago.us](http://www.wago.us)

Do you have any questions about our products?  
We are always happy to take your call at (262) 255-6222 or 1 800-DIN-RAIL.

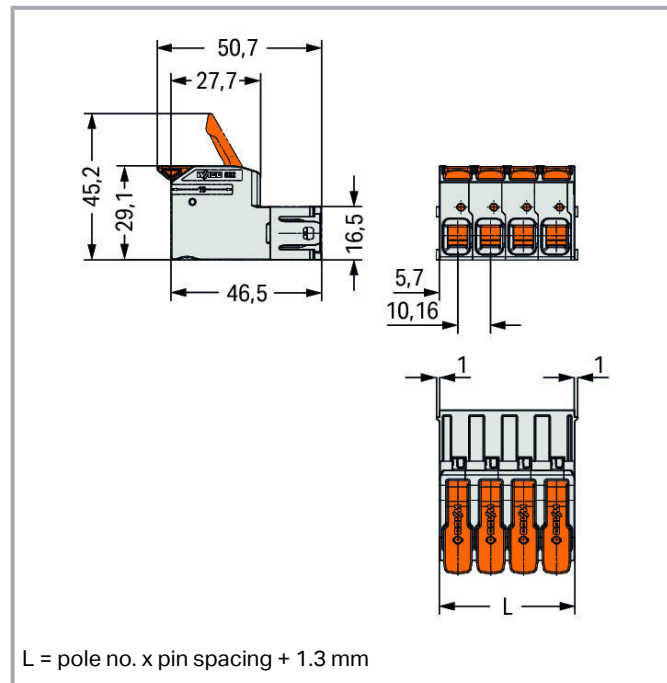
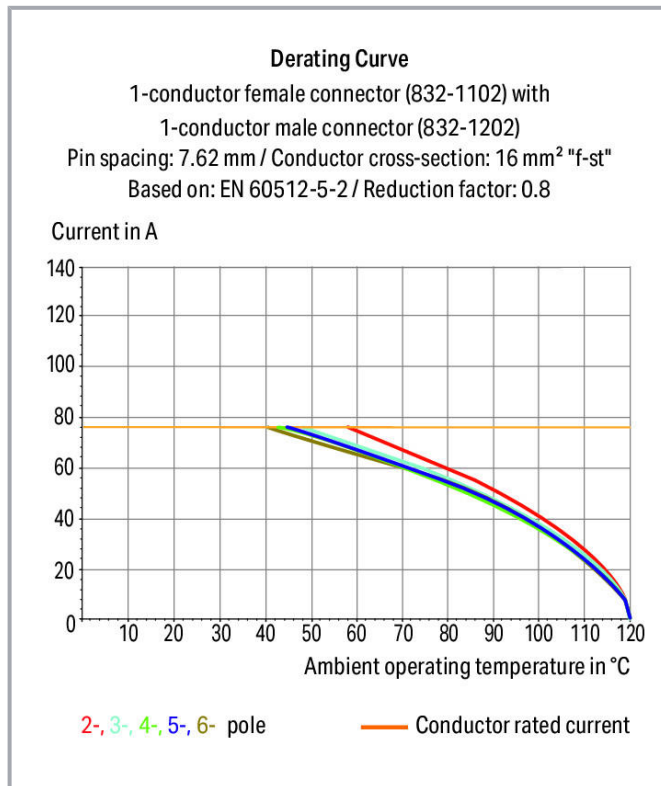

## Item description

- Intuitive and tool-free lever actuation
- Universal connection for all conductor types
- Push-in termination of solid or ferruled conductors
- Test slot 0° and 90° to conductor entry
- 100% protected against mismatching
- Coding option available

## Safety information 1:

The MCS – MULTI CONNECTION SYSTEM includes connectors without breaking capacity in accordance with DIN EN 61984. When used as intended, these connectors must not be connected/disconnected when live or under load. The circuit design should ensure header pins, which can be touched, are not live when unmated.

## Data

### Electrical data

Subject to changes. Please also observe the further product documentation!



## IEC Approvals

Ratings per	IEC/EN 60664-1
Rated voltage (III / 3)	1000 V
Rated surge voltage (III/3)	8 kV
Rated voltage (III/2)	1000 V
Rated surge voltage (III/2)	8 kV
Nominal voltage (II/2)	1000 V
Rated surge voltage (II/2)	8 kV
Rated current	76 A
Legend (ratings)	(III / 2) $\triangleq$ Overvoltage category III / Pollution degree 2

## UL Approvals

Approvals per	UL 1059
Rated voltage UL (Use Group B)	600 V
Rated current UL (Use Group B)	66 A
Rated voltage UL (Use Group C)	600 V
Rated current UL (Use Group C)	66 A

## Ratings per UL

Rated voltage UL 1977	600 V
Rated current UL 1977	85 A

## CSA Approvals

Approvals per	CSA
Rated voltage CSA (Use Group B)	600 V
Rated current CSA (Use Group B)	66 A
Rated voltage CSA (Use Group C)	600 V
Rated current CSA (Use Group C)	66 A

## Connection data

Connection technology	Push-in CAGE CLAMP®
Actuation type	Lever
Solid conductor	0.75 ... 16 mm <sup>2</sup> / 18 ... 4 AWG
Fine-stranded conductor	0.75 ... 25 mm <sup>2</sup> / 18 ... 4 AWG
Fine-stranded conductor; with insulated ferrule	0.75 ... 16 mm <sup>2</sup>

Subject to changes. Please also observe the further product documentation!



Fine-stranded conductor; with uninsulated ferrule	0.75 ... 16 mm <sup>2</sup>
Strip length	18 ... 20 mm / 0.71 ... 0.79 inch
Pole No.	6
Total number of potentials	6
Number of connection types	1
Number of levels	1

### Physical data

Pin spacing	10.16 mm / 0.4 inch
Width	62.26 mm / 2.451 inch
Height	29.1 mm / 1.146 inch
Depth	111.6 mm / 4.394 inch

### Plug-in connection

Contact type (pluggable connector)	Male connector/plug
Connector (connection type)	for conductor
Mismatching protection	Yes
Locking of plug-in connection	Without
Strain relief	Strain relief plate

### Material data

Color	light gray
Material group	I
Insulation material	Polybutylene terephthalate (PBT)
Flammability class per UL94	V0
Clamping spring material	Chrome nickel spring steel (CrNi)
Contact material	Electrolytic copper (E <sub>Cu</sub> )
Contact plating	silver-plated
Color of actuator	orange
Weight	79.2 g

### Environmental requirements

Limit temperature range	-60 ... +120 °C
-------------------------	-----------------

### Commercial data

Packaging type	BOX
----------------	-----

Subject to changes. Please also observe the further product documentation!

WAGO Corporation  
 Germantown, WI 53022  
 Phone: 1-800-DIN-RAIL (346-7245) | Fax: (262) 255-6222  
 Email: [info.us@wago.com](mailto:info.us@wago.com) | Web: [www.wago.us](http://www.wago.us)

Do you have any questions about our products?  
 We are always happy to take your call at (262) 255-6222 or 1 800-DIN-RAIL.

Country of origin	DE
GTIN	4055143938198
Customs tariff number	8536694040

## Approvals / Certificates

### UL-Approvals

Logo	Approval	Additional Approval Text	Certificate name
	UL Underwriters Laboratories Inc.	C22.2 No. 158	E45172

## Counterpart









Item no.832-1106

Female plug; Push-in CAGE CLAMP with operating lever; AWG 18 - 4; Pin spacing 10.16 mm; 6-pole

[www.wago.com/832-1106](http://www.wago.com/832-1106)

## Optional accessories

### Ferrules

	Item no.: 216-210 Ferrule; Sleeve for 16 mm <sup>2</sup> / AWG 6; insulated; electro-tin plated; electrolytic copper; gastight crimped; acc. to DIN 46228, Part 4/09.90; blue	<a href="http://www.wago.com/216-210">www.wago.com/216-210</a>
	Item no.: 216-284 Ferrule; Sleeve for 1.5 mm <sup>2</sup> / AWG 16; insulated; electro-tin plated; electrolytic copper; gastight crimped; acc. to DIN 46228, Part 4/09.90; black	<a href="http://www.wago.com/216-284">www.wago.com/216-284</a>
	Item no.: 216-286 Ferrule; Sleeve for 2.5 mm <sup>2</sup> / AWG 14; insulated; electro-tin plated; electrolytic copper; gastight crimped; acc. to DIN 46228, Part 4/09.90; blue	<a href="http://www.wago.com/216-286">www.wago.com/216-286</a>
	Item no.: 216-287 Ferrule; Sleeve for 4 mm <sup>2</sup> / AWG 12; insulated; electro-tin plated; electrolytic copper; gastight crimped; acc. to DIN 46228, Part 4/09.90; gray	<a href="http://www.wago.com/216-287">www.wago.com/216-287</a>
	Item no.: 216-288 Ferrule; Sleeve for 6 mm <sup>2</sup> / AWG 10; insulated; electro-tin plated; electrolytic copper; gastight crimped; acc. to DIN 46228, Part 4/09.90; yellow	<a href="http://www.wago.com/216-288">www.wago.com/216-288</a>
	Item no.: 216-289 Ferrule; Sleeve for 10 mm <sup>2</sup> / AWG 8; insulated; electro-tin plated; electrolytic copper; gastight crimped; acc. to DIN 46228, Part 4/09.90; red	<a href="http://www.wago.com/216-289">www.wago.com/216-289</a>

### Coding

★	Item no.: 832-500	<a href="http://www.wago.com/832-500">www.wago.com/832-500</a>
---	-------------------	--

Subject to changes. Please also observe the further product documentation!



Coding key carrier; orange

---

## Downloads

### Documentation

#### Additional Information

Technical explanations	Apr 3, 2019	pdf 2.0 MB	Download
------------------------	-------------	---------------	----------

---

## Environmental Product Compliance

### Compliance Search

Environmental Product Compliance 832-1206/334-000 1-conductor male connector; lever; Push-in CAGE CLAMP®; 16 mm <sup>2</sup> ; Pin spacing 10.16 mm; 6-pole; 100% protected against mismatching; Strain relief plate; Silver-plated contacts; 16,00 mm <sup>2</sup> ; light gray	URL	Download
---	-----	----------

---

## Installation Notes

### Product family

<i>MCS</i> MAXI 16

[Show all products from the family](#)

Subject to changes. Please also observe the further product documentation!

---

WAGO Corporation  
Germantown, WI 53022  
Phone: 1-800-DIN-RAIL (346-7245) | Fax: (262) 255-6222  
Email: [info.us@wago.com](mailto:info.us@wago.com) | Web: [www.wago.us](http://www.wago.us)

Do you have any questions about our products?  
We are always happy to take your call at (262) 255-6222 or 1 800-DIN-RAIL.